

TRANSFORMERS

ELECTROSTATIC JOLT™

LEVEL: 0 1 2 **3** 4 5

INTERMEDIATE

AUTOBOT™

NOTE: Some parts are made to detach if excessive force is applied and are designed to be reattached if separation occurs. Adult supervision may be necessary for younger children.



AGES 5+
20905/98447 ASST.

TRANSFORMERS.COM

CHANGING TO ROBOT

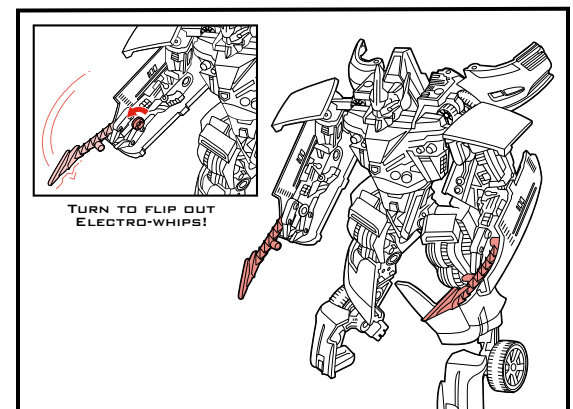
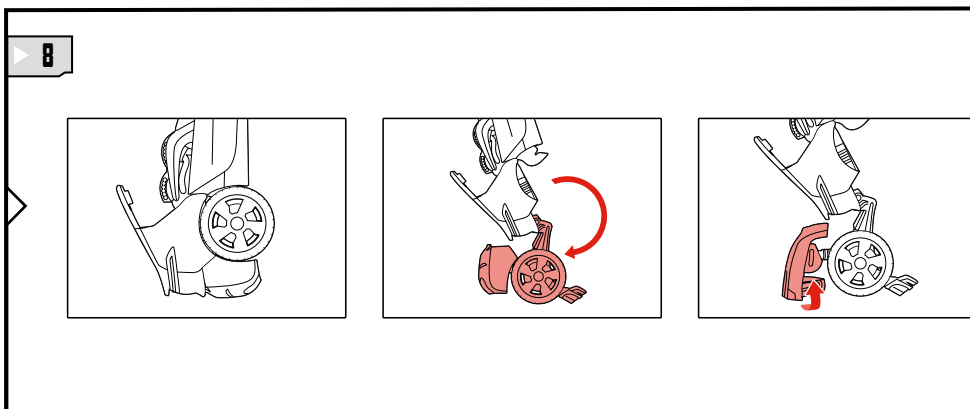
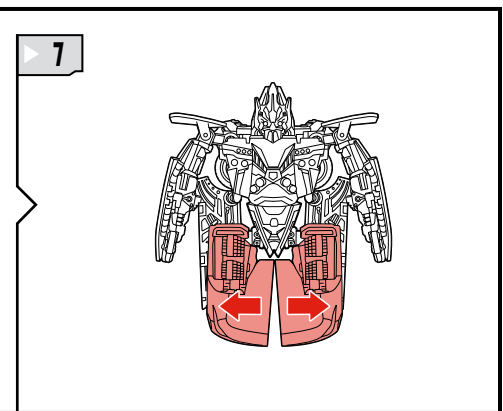
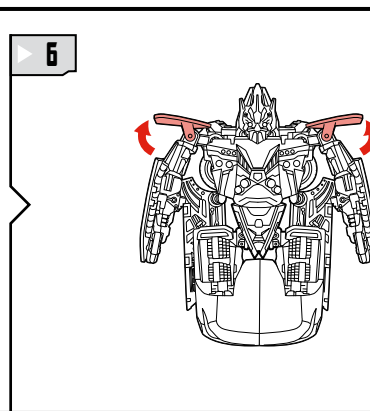
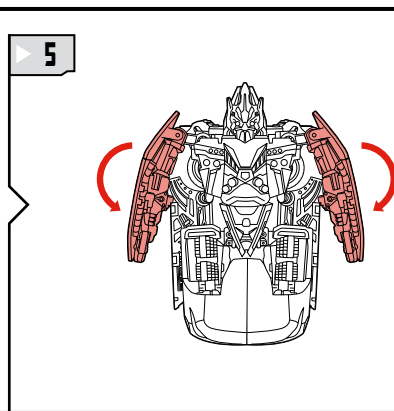
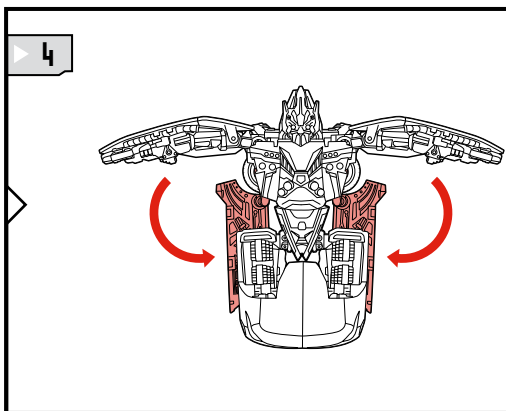
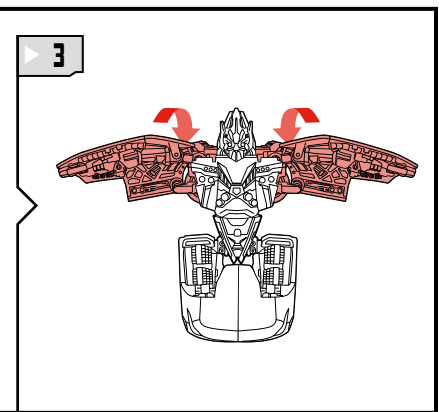
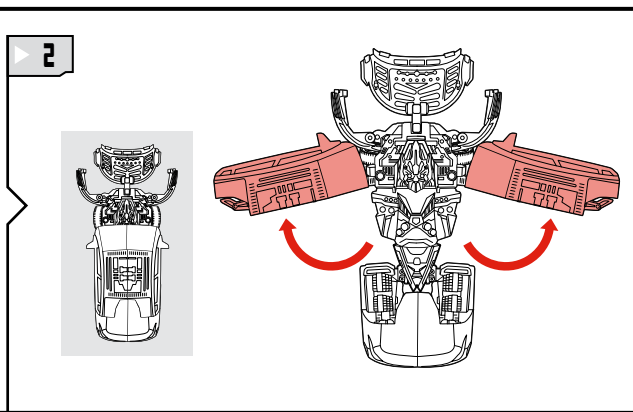
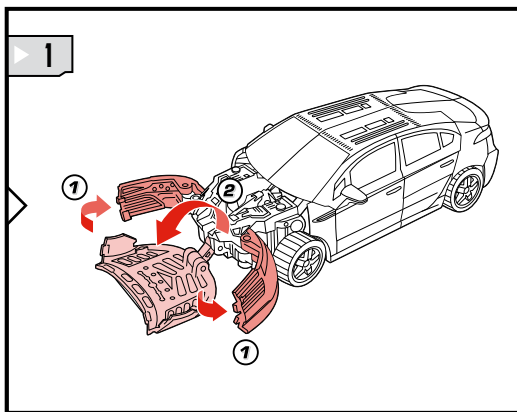
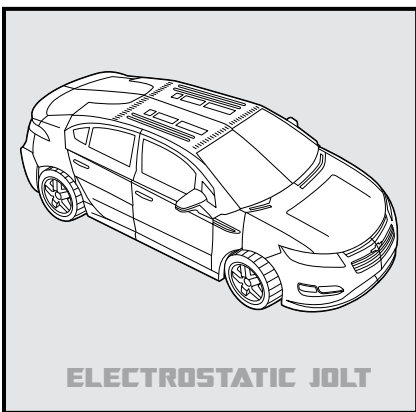

CHANGING TO VEHICLE

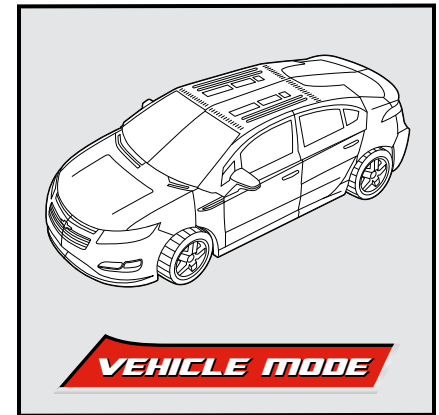
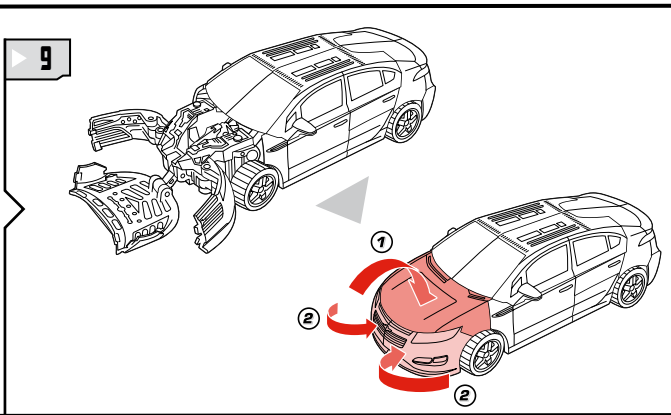
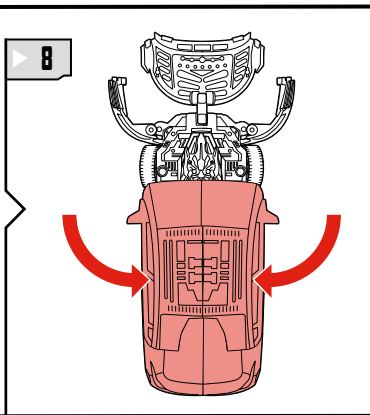
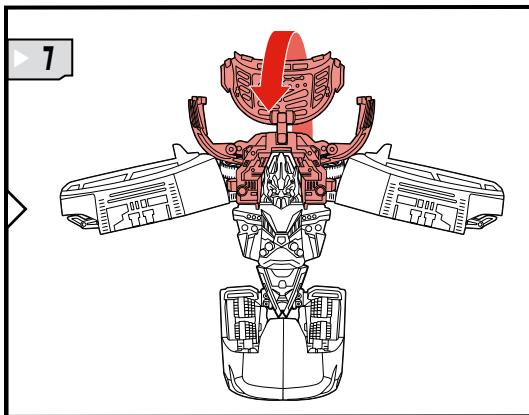
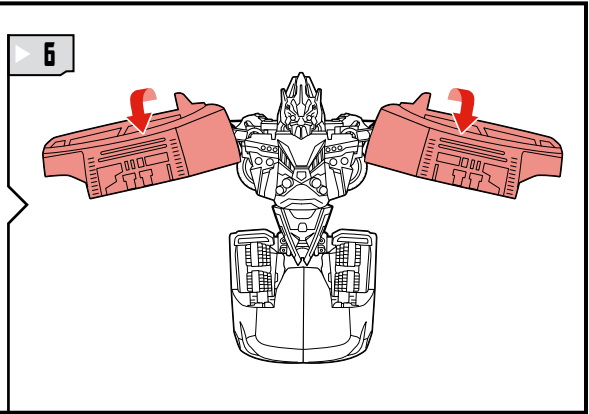
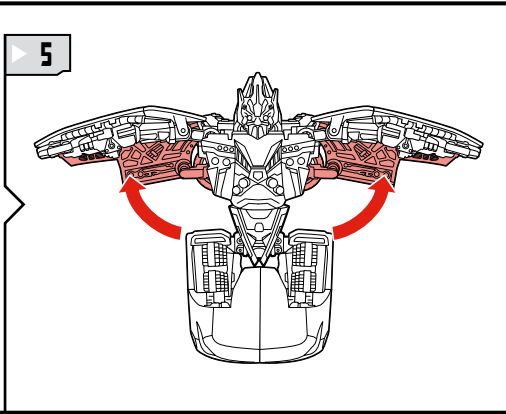
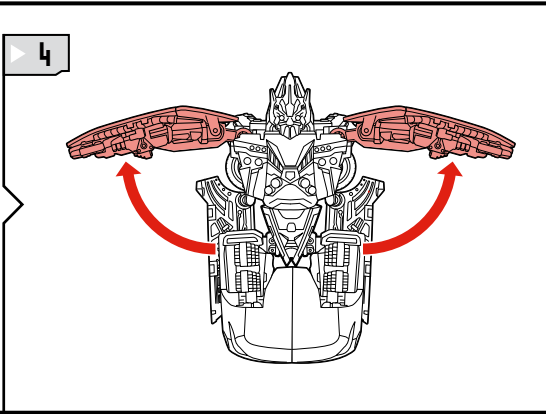
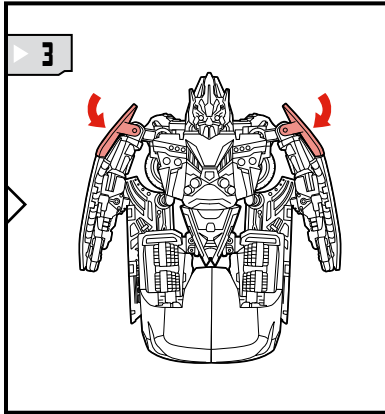
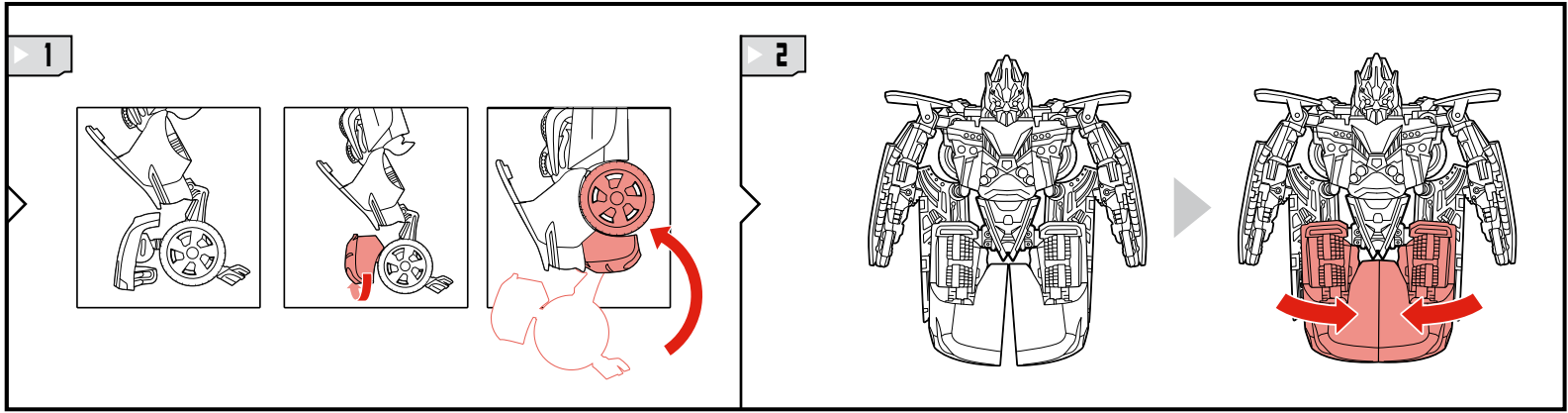
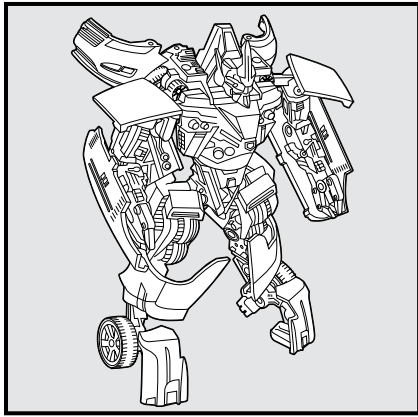

Retain instructions for future reference.



© 2010 DreamWorks LLC and Paramount Pictures Corporation
 ® and/or TM® & © 2010 Hasbro. All Rights Reserved.
 TM & ® denote U.S. Trademarks.
 Manufactured under license from Tomy Company, Ltd.



NEED HELP?
TRANSFORMERS.COM/INSTRUCTIONS

Some poses may require hand support.



Product and colors may vary.



Chevy Volt and all related Emblems and vehicle body designs are General Motors Trademarks used under license to Hasbro, Inc.

P/N 7094570000



Not suitable for children under 3 years because of small parts – choking hazard.